

# TEMPEST: Test EnvironMent for Performance Evaluation of the Scheduling of packeTs

Carlo Augusto Grazia, Maurizio Casoni, Paolo Valente

Department of Engineering *Enzo Ferrari*  
University of Modena and Reggio Emilia



Larnaca, Cyprus, October 8, 2014  
**Emergency Networks for PPDR Workshop**  
Part of IEEE WiMob 2014

# Talk overview

- 1 Introduction
  - Problem
  - State of the Art
- 2 Proposed solution
- 3 Results
  - Choosing the right scheduler
  - Implementing novel solutions
- 4 Conclusions

# Problem

## what

to easily evaluate packet scheduling solutions

- execution time
- QoS guarantees
- throughput

## why

emerging fields need packet scheduling

- 3G/4G, LTE, Emergency Networks
- Technologies QoS driven

## how

TEMPEST

# State of the Art

## typical solution

simulated environment vs emulated environments

## weaknesses

- simulators
  - **easy** to set up a suitable test environment
  - **hard** to import/export real code
  - time is simulated!
- emulators
  - **hard** to set up a suitable test environment
  - **easy** to import/export real code
  - packet generation, reception, device drivers and other costs dominate the measurements;

# TEMPEST

Test EnvironMent for Performance Evaluation of the Scheduling of packeTs  
 UNIX-based open tool able to measure the *actual performance* of a packet scheduler under the desired operating conditions

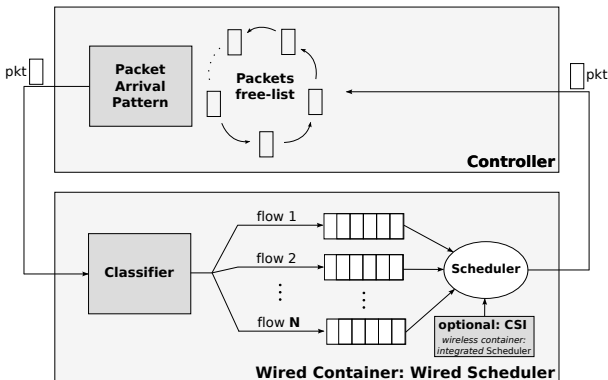

# TEMPEST modules 1/3: The Controller

## TEMPEST Controller

simulates the desired realistic packet arrival pattern

- manages a free list of fake packets
- uses fake packets to reduce the system overhead (40Mpps)
- controls the number of pending packets
- total low-level control of queues state

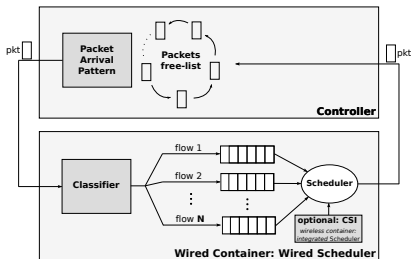

# TEMPEST modules 2/3: The Container

## TEMPEST Container

featherweight model which incapsulates a packet scheduler

- runs kernel code in user space
- easy code porting kernel  $\leftrightarrow$  tempest with trivial interface changes
- tracks information for QoS and throughput measurements

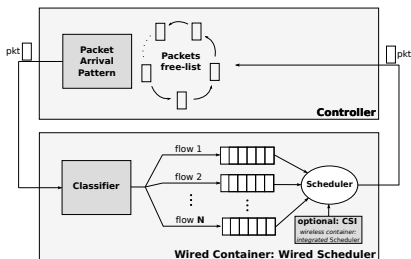

# TEMPEST modules 3/3: Channel State Information (CSI)

## TEMPEST CSI

the simulation engine behind the wireless scenario representation

- optional block
- used for wireless simulations
- gives channel feedback:  $S_nR$  or  $P_{loss}$
- cross-layering solution

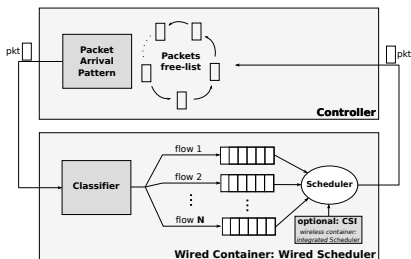



# TEMPEST details

## Core

TEMPEST gives a fine-grained level of configuration parameters in a hybrid simulation/emulation tool

## Keypoints

From the **emulation** side:

- time is real
- code is real too

From the **simulation** side:

- QoS metrics are simulated
- Throughput and CSI are simulated
- simulated measures are exact!

# TEMPEST default schedulers

- **DRR**:  $\mathcal{O}(1)$  time complexity,  $\mathcal{O}(n)$  deviation from optimal service
- **WF<sup>2</sup>Q+**: a *timestamp-based* algorithm with optimal service guarantees in  $\mathcal{O}(\log n)$  time
- **KPS**: approximated timestamp-based schedulers with near-optimal guarantees and  $\mathcal{O}(1)$  time complexity (slower than DRR)
- **QFQ**: approximated timestamp-based schedulers with near-optimal guarantees and  $\mathcal{O}(1)$  time complexity (as fast as DRR)
- **QFQ+**: improvement of QFQ sometimes faster than DRR
- **W<sup>2</sup>F<sup>2</sup>Q**: integrated packet scheduler for wireless link based on WF<sup>2</sup>Q+ algorithm
- **HFS**: a modular packet scheduler for wireless link, based on QFQ+, with  $\mathcal{O}(1)$  time complexity, quasi-optimal service guarantees, high throughput and low energy consumption

# TEMPEST input parameters

parameter	short description	default value
n	amount of events for the run	null
qmin	min controller's pending packets	0
qmax	max controller's pending packets	0
len	length of packets in byte	1700
burst	set predefined packet arrival patters	0
qsing	minimum packets number per flow	0
mode	choose the container	null
alg	scheduler algorithm	FIFO
qos	QoS scheduler algorithm	null
mac	MAC scheduler algorithm	null
flowsets	define the QoS flows characteristics	null
flows	define the number of QoS flows	0
flowsetsmac	define the MAC flows characteristics	null
flowsmac	define the number of MAC flows	0
qmac	define the Q shared-buffer size in packets	0
wdistr	define MAC weight distribution	0
ploss	assign a packet loss for each MAC flow	null
intgr_th	define the good/bad threshold	50%

controller

container

CSI

# Choosing the right scheduler

We have many algorithms with different features. How do we choose?

- it depends on the operating conditions:
  - for large  $N$ , asymptotic complexity is important.
  - for small  $N$ , or certain weight distributions, guarantees or *actual* run times are more important
- theory can tell us about worst-case service guarantees and asymptotic complexity
- we need measurements to determine the run-time constants

# Execution time behavior for different schedulers (lower is better)

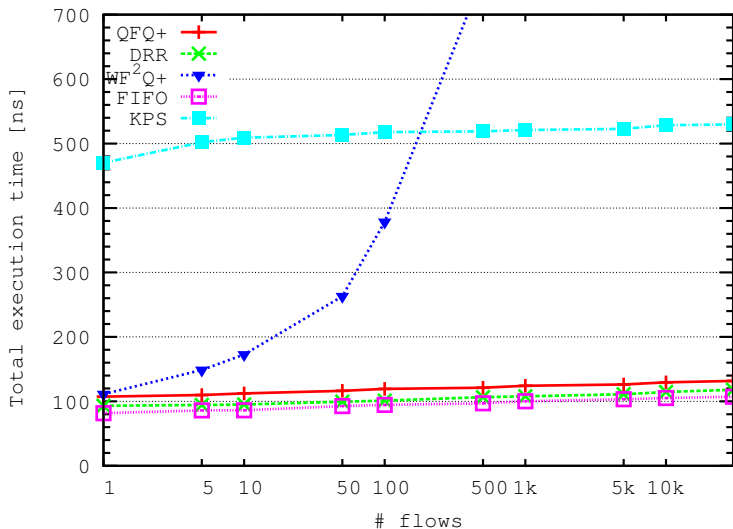

# Execution time with *bursty* packets arrival pattern (lower is better)

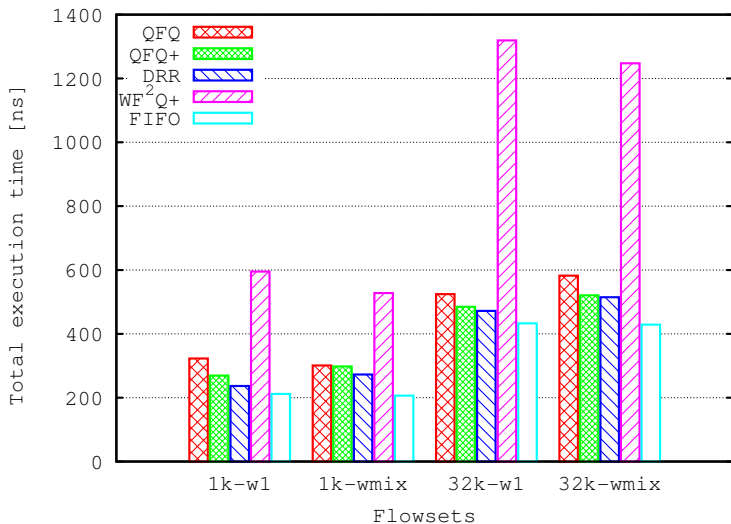

# Implementing novel solutions in challenging scenarios

We have several novel technologies QoS driven:

- quickly evaluate novel scheduling solution
- real code is basically the TEMPEST code
- PPDR systems are a perfect challenging example:
  - technologies/architectures used are still evolving
  - thin QoS guarantees on a tough environment

# PPDR case study

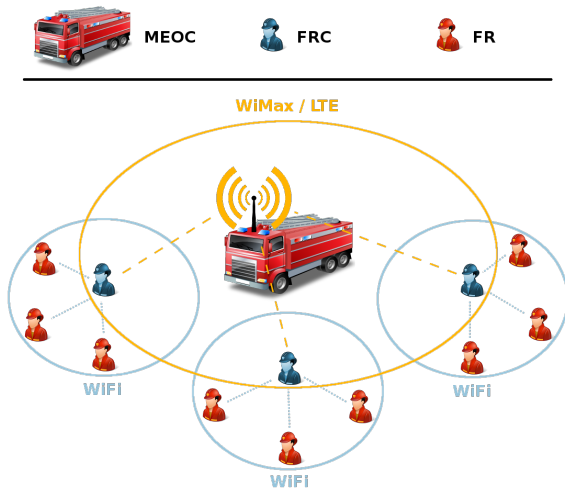



# PPDR case study: T-WFI for different scheduler (lower is better)

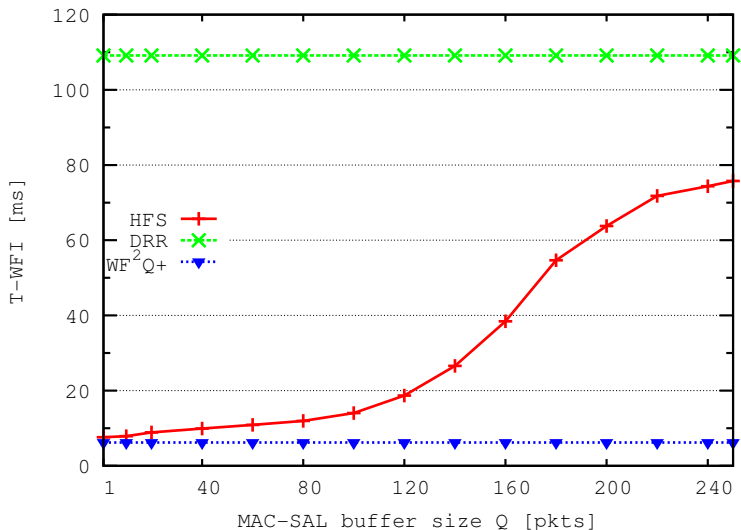

# PPDR case study: throughput achieved (higher is better)

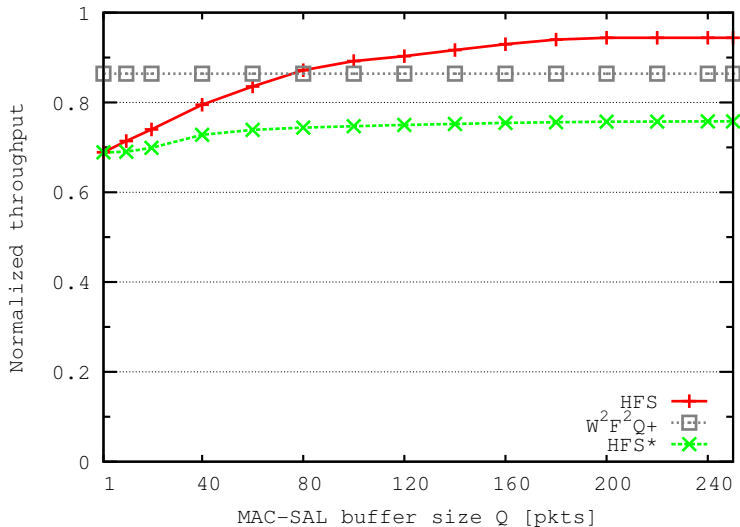

# Conclusions

## TEMPEST

a novel test environment for packet scheduling evaluation/implementation

### Characteristics

- open and UNIX based
- hybrid simulator-emulator
- measures all the main figures of merit
- flexible and suitable for PPDR systems and challenging environments
- tests proof its accuracy
- support novel technologies/standards
- help research!

thank you  
for your attention

[carloaugusto.grazia@unimore.it](mailto:carloaugusto.grazia@unimore.it)

extra slides

# Reference Scenario

- 20 first responders (FR)
- link rate 54 Mb/s
- one MAC-SAL flow per FR
- MAC-SAL flow packet loss probability
  - ranging linearly from  $10^0$  to  $10^{-1}$
  - outsider values as  $10^{-2}$ ,  $10^{-3}$  and  $10^{-4}$
  - static
- MAC-SAL flow weight distribution
  - analogical:  $\phi_k = (1 - P_{loss_k}) \cdot 1000$
- 100 QoS flows with different weights